



PRODUCT SPECIFICATION

LCD Android Board
HD-3288S

Version: V2.1

Update History

Version	Release time	Description
V2.1	Oct. 13, 2023	Update content layout,Modify known errors.
V1.1	Aug. 30, 2023	First official release.

Contents

Chapter I Product description.....	4
I . Overview	4
II. Features	4
Chapter II Specifications.....	5
I . Basic parameters.....	5
1. Hardware parameters	5
2. Software parameters.....	6
II. Product size specifications.....	8
III. Product interface diagram	9
IV. Interface parameter description.....	9
1. PWR/DC (power input) interface	9
2. MIC (Microphone) Interface and Definition	10
3. LED/IR (Remote control) interface and definition	10
4. LVDS BL (LVDS backlight) interface.....	11
5. EDP BL (EDP backlight) interface and definition	11
6. LVDS Interface and Definition.....	12
7. EDP interface and definition.....	13
8. USB Interface and Definition.....	14
9. SPK (Power amplifier) Interface	14
10. L/R (Audio Interface and Definition).....	15
11. GPIO Interface (extension) and Definition	15
12. UART (Serial Port) Port*2.....	15
13. DEBUG interface.....	16
14. 4PIN RJ45 (Ethernet port).....	16
15. TP Interface	17
16. 16pin HDMI OUT Interface.....	17
17. KEY Interface (extension) and Definition	18
18. MCU Interface and Definition	18
19. Other Interfaces.....	19
Chapter III Communication Methods	20
I . Wi-Fi Update Program	20
II. U-disk update program	20

III. TF Card Update Program.....	21
IV. Ethernet cable to Update.....	21
V. Internet Update.....	22
Chapter IV Appendix: Product Appearance	22

Chapter I Product description

I. Overview

HD-3288S is an all-in-one motherboard, using Rockchip RK3288 quad-core chip solution, equipped with Android 7.1.2 system, the main frequency is up to 1.8GHz, with super performance. Adopts Mali-T764 GPU, supports AFBC (Frame Slow Slave Compression), 4K/H.265 hard decoding, 1080P video decoding, HDMI interface 4K output, 4K video playback. Supports infrared remote control, Wi-Fi, RJ45 and other rich interfaces to make the product more versatile. It is widely used in advertising, interactive all-in-one, security, medical, transportation, finance, industrial control and other intelligent control fields, which can accelerate Product development cycle. Due to its hardware platform and Android's intelligent characteristics, when it is necessary to perform human-computer interaction and network device interaction, it can be used on the smart terminal motherboard, which can become your best choice.

HD-3288S is standard with 2.4GHz frequency Wi-Fi module (optional 5GHz frequency), supports Bluetooth 4.2, support transferring file via Bluetooth.

II. Features

- High performance. Uses a quad-core ARM Cortex-A17 architecture, the main frequency can be as high as 1.8GHz, compared with the single-core, dual-core, and quad-core solutions common in the market. It has a qualitative leap in performance, can play high-definition video in various formats, and can handle complex interactive operations.
- High stability. RK3288 Android integrated board, in hardware and software, add your own unique technology to ensure the stability of the product, can make the final product 7 * 24 hours unattended.
- High integration. RK3288 Android integrated board integrates Ethernet, EDP, Wi-Fi, power amplifier, TF expansion card, USB expansion port, IR remote control function, HDMI, LVDS, backlight control, microphone and other functions, greatly simplifying the overall design.
- High scalability. SIX expansion USB ports (4 ports are PIN type, 2 ports are standard type), 2 serial ports + 1 expandable debug serial port, five IO expansion ports can expand more peripheral device.

- High definition. Supporting various LVDS / EDP / HDMI interfaces and cropping screens of various sizes and resolutions.
- Perfectly support multiple mainstream touch screen functions such as multi-point infrared touch, multi-point capacitive touch, multi-point nano film touch, multi-point acoustic wave touch, multi-point optical touch, etc.

Chapter II Specifications

I . Basic parameters

1. Hardware parameters

Hardware specifications	
CPU	RK3288, Quad-core, the highest frequency 1.8GHz, Android 7.1.2
GPU	Mail-T764 GPU MP4 Quad-core GPU Supports OpenGL ES1.1/2.0,OpenVG1.1,OpenCL
RAM/ Storage	Standard 2GB+32GB, 4GB+32GB, 4GB+64GB
Network	Support RJ45 R / A 100M Ethernet, support Ethernet. Supports 2.4G / 5G Wi-Fi and Wi-Fi 802.11b / g / n protocols. Support Bluetooth 4.2, transferring file by Bluetooth.
Image rotation	Support manual rotation of 0 degrees, 90 degrees, 180 degrees, 270 degrees
Display interface	1 * LVDS interface (single / dual, 6-bit / 8-bit), support 3.3V / 5V / 12V power supply 1 EDP interface, 1 HDMI1.4 interface, support 4K output Support dual screen simultaneous display function, can directly drive interface LCD screen with multiple resolutions Onboard backlight control supports 12V backlight power supply
Audio	Support standard left and right channel line output
Power amplifier	2 outputs (8 ohms, 5 watts dual audio amplifier output)
Microphone	Differential MIC input
Touch screen	Support USB multi-point infrared touch, multi-point capacitive touch, multi-point nano film touch, multi-point acoustic wave Touch, multi-point optical touch and more.

RTC	Built-in real-time clock function
USB	1 USB-2.0 HOST, 1 USB-2.0 OTG, 4 extended USB ports (one of USB share with 4G module)
Infrared	Infrared receiver, support infrared remote control function
LED	1 * Power status LED (green), 1 * System LED (green, blinking by default)
Button	1 * upgrade key
Serial port	2 UART port, 1 DEBUG port
IO port	5 IO input and output control, can be used as key scanning control
Power Adapter	Input: AC100-240V.50-60HZ, Output: DC12V 1.5A (Requires surge voltage less than 18V and ripple voltage less than 100mV)
Storage Humid	10%~90% RH
Storage Temp	-40°C~70°C
Work Temp	-20°C~70°C

2. Software parameters

Software specifications	
operating system	Android 7.1.2 (Optional Android 10.0)
Audio	MP3, WMA, WAV, APE, FLAC, AAC, OGG, M4A, 3GPP and other formats
Video	Support H.264, VP8, MAV, WMV, AVS, H.263, MPEG4 and other video formats 1080P multi-video decoding
Image	Support various image formats such as JPG, BMP, PNG
System comes with application software	APK Installer, Email, Calculator, Browser, Recorder, Calendar, Settings, Clock, Video Player, Search, Contacts, Gallery, Download, Camera, Music, Explorer, etc.

Language	support multi-language
Input	Standard Android keyboard with optional third-party input method
System Management	Original ecological Android system, open root permissions, and can customize product development
	Real-time remote monitoring, system crash self-recovery, unattended 7 * 24 hours
	Support OTA remote upgrade; support U disk upgrade
	Support boot animation definition
	Support server / stand-alone mode switching
	Support Wi-Fi hotspot
System watchdog	Support software watchdog

II. Product size specifications

1. Bare board size specification, unit: mm (mm)

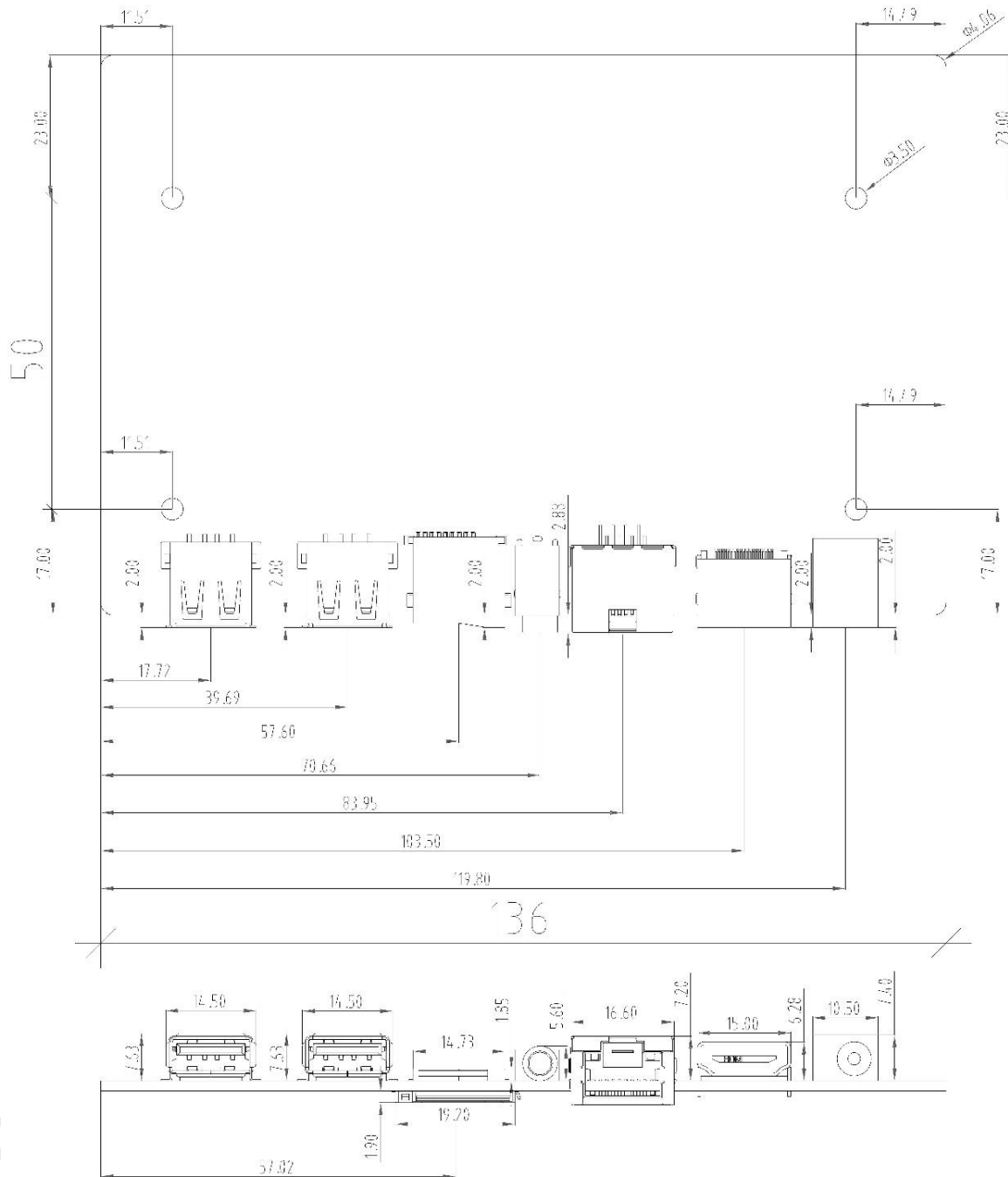

III. Product interface diagram

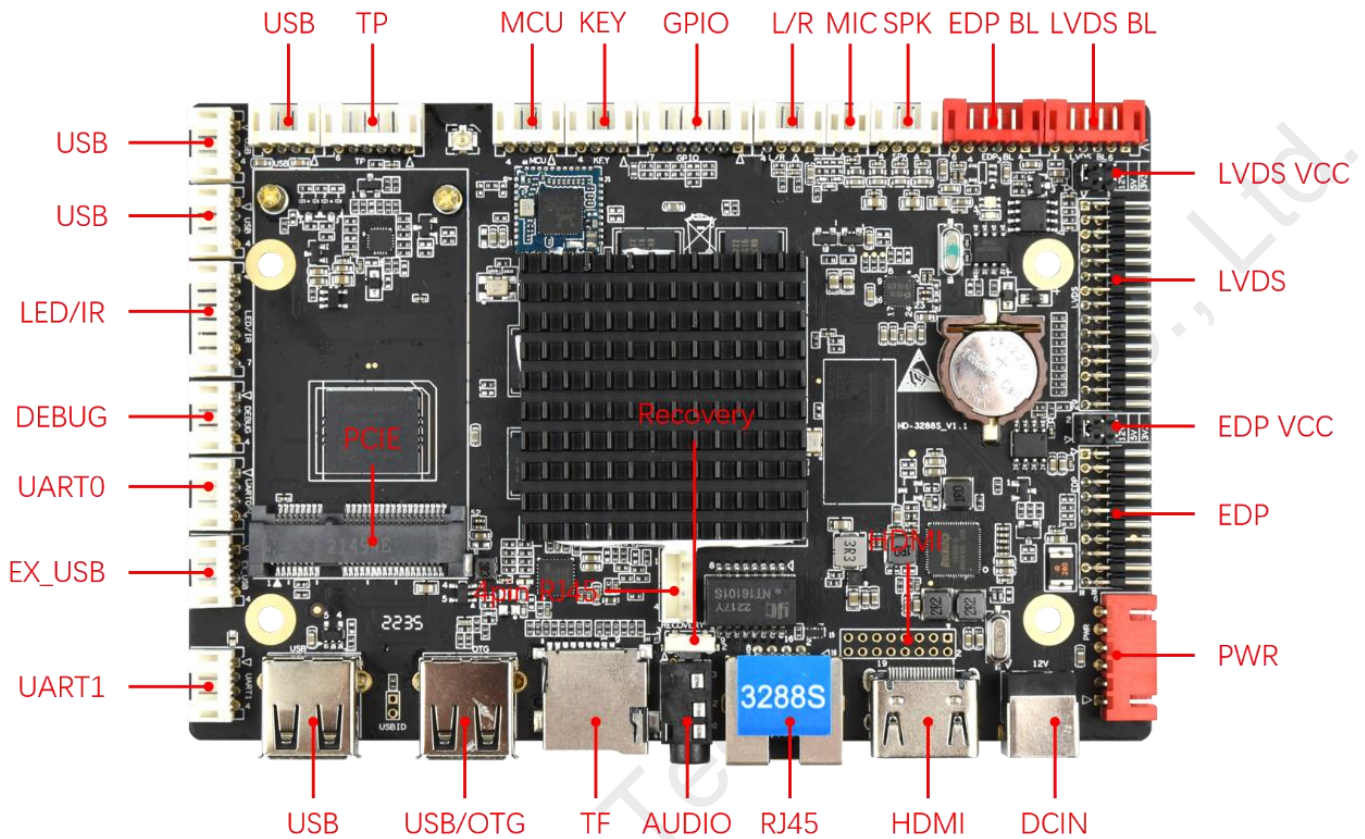

IV. Interface parameter description

1. PWR/DC (power input) interface

It adopts 12V DC power supply and only allows the board subsystem to be powered from the DC socket and power socket.

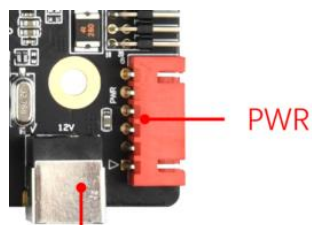

No.	Definition	Attributes	Description
6	12V	Input	12V Input

5	12V	Input	12V Input
4	GND	Ground	Ground
3	GND	Ground	Ground
2	5VS	Input	Standby 5V Input
1	STB	Output	Standby signal output

Note: The inner diameter of the DC power port is 2.0mm, and the outer diameter is 5.8mm.

2. MIC (Microphone) Interface and Definition

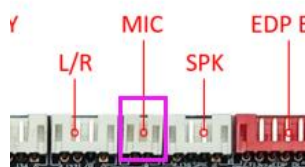

No.	Definition	Attributes	Description
1	MIC-P	Input	MIC+Input
2	MIC-N	Input	MIC-Input

3. LED/IR (Remote control) interface and definition



No.	Definition	Attributes	Description
1	RED	Output	Red light
2	5V	Power	5V Output
3	GRN	Output	Green light
4	IO	Output	Remote signal output
5	IR	Input	Remote signal Input
6	GND	Ground	Ground
7	5V	Power	5V Output

4. LVDS BL (LVDS backlight) interface

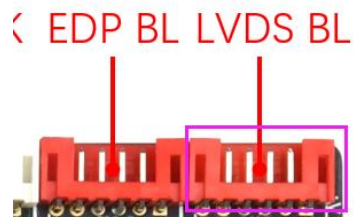

No.	Definition	Attributes	Description
1	GND	Ground	Ground
2	GND	Ground	Ground
3	ADJ	Output	Backlight brightness control
4	EN	Output	Backlight enable control
5	12V	Power	12V output
6	12V	Power	12V output

5. EDP BL (EDP backlight) interface and definition

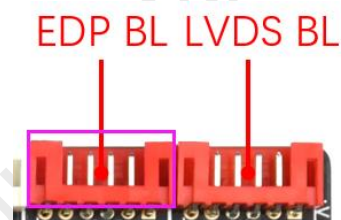

No.	Definition	Attributes	Description
1	GND	Ground	Ground
2	GND	Ground	Ground
3	ADJ	Output	Backlight brightness control
4	EN	Output	Backlight enable control
5	12V	Power	12V output
6	12V	Power	12V output

6. LVDS Interface and Definition

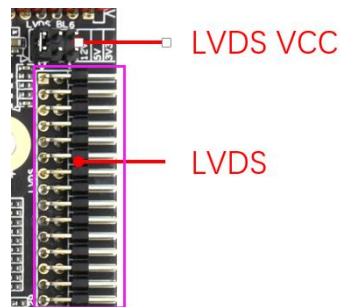

General LVDS interface definition, support single / dual, 6/8 / 10-bit 1080P LVDS screen. The screen voltage can be selected through a jumper cap, and it can be selected to support 3.3V / 5V / 12V screen power supply.

In order to avoid burning boards and screens, please note the following:

1. Please confirm whether the screen specification book screen supply voltage is correct, whether the board's corresponding power supply can meet the maximum working current of the screen.
2. Please use multimeter to confirm that the power supply selected by the jumper cap is correct.
3. When connecting the 6 / 8-bit LVDS screen cable, install it near pin1.

No.	Definition	Attributes	Description
1	VCC	Power	3.3V / 5V / 12V optional output
2	VCC		
3	VCC		
4	GND	Ground	Ground
5	GND	Ground	Ground
6	GND	Ground	Ground
7	RXO0-	Output	Odd 0-
8	RXO0+	Output	Odd 0+
9	RXO1-	Output	Odd 1-
10	RXO1+	Output	Odd 1+
11	RXO2-	Output	Odd 2-
12	RXO2+	Output	Odd 2+
13	GND	Ground	Ground
14	GND	Ground	Ground
15	RXOC-	Output	Odd Clock-
16	RXOC+	Output	Odd Clock+
17	RXO3-	Output	Odd 3-
18	RXO3+	Output	Odd 3+
19	RXE0-	Output	Even 0-
20	RXE0+	Output	Even 0+
21	RXE1-	Output	Even 1-
22	RXE1+	Output	Even 1+
23	RXE2-	Output	Even 2-
24	RXE2+	Output	Even 2+

25	GND	Ground	Ground
26	GND	Ground	Ground
27	RXEC-	Output	Even Clock-
28	RXEC+	Output	Even Clock+
29	RXE3-	Output	Even 3-
30	RXE3+	Output	Even 3+

7. EDP Interface and Definition

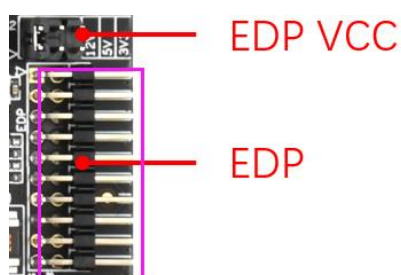

This interface is a common EDP screen interface, in the form of 10 * 2 double row pins, 3.3V screen power supply. In order to avoid burning boards and screens, please note the following:
 Confirm that the screen specification book screen supply voltage is correct and whether the board's corresponding power supply can meet the screen's maximum working current.

No.	Definition	Attributes	Description
1	VCC	Power	output
2	VCC	Power	output
3	GND	Ground	Ground
4	GND	Ground	Ground
5	T0P	Output	True Signal Link Lane 0
6	T0N	Output	Complement Signal Link Lane 0
7	T1P	Output	True Signal Link Lane 1
8	T1N	Output	Complement Signal Link Lane 1
9	T2P	Output	True Signal Link Lane 2
10	T2N	Output	Complement Signal Link Lane 2
11	T3P	Output	True Signal Link Lane 3
12	T3N	Output	Complement Signal Link Lane 3
13	GND	Ground	Ground
14	GND	Ground	Ground
15	AUP	Output	True Auxiliary Channel
16	AUN	Output	Complement Signal Link Lane 0
17	GND	Ground	Ground
18	GND	Ground	Ground
19	GND	Ground	Ground
20	GND	Ground	Ground

8. USB Interface and Definition

The board has 2 USB standard interfaces (the left one is device mode), 2 built-in USB sockets for peripheral expansion.

USB Interface

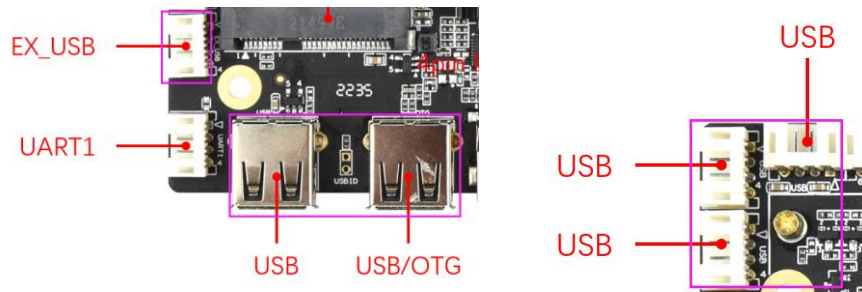

No.	Definition	Attributes	Description
1	5VS	Power	5V Output
2	DM	Input / output	DM
3	DP	Input / output	DP
4	GND	Ground	Ground

9. SPK (Power amplifier) Interface

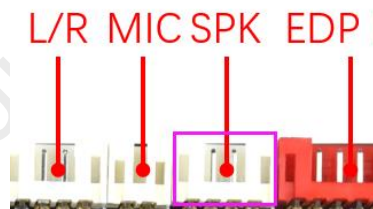

NO.	Definition	Attributes	Description
1	OUTP-R	Output	Right channel +
2	OUTN-R	Output	Right channel-
3	OUTN-L	Output	Left channel-
4	OUTP-L	Output	Left channel+

10. L/R (Audio Interface and Definition)

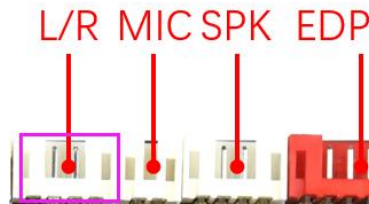

NO.	Definition	Attributes	Description
1	LO-L	Output	Left channel
2	LO-R	Output	Right channel
3	GND	Ground	Ground
4	NC	NC	No definition

11. GPIO Interface (extension) and Definition

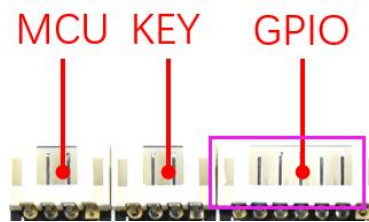

NO.	Definition	Attributes	Description
1	GND	GND	GND
2	K5	K5	K5
3	K4	K4	K4
4	K3	K3	K3
5	K2	K2	K2
6	K1	K1	K1
7	3V3	POWER	DC 3.3V Output

12. UART (Serial Port) Port*2

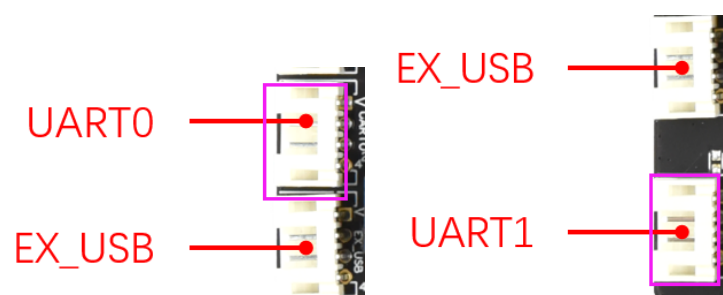

The board have to two sets of ordinary UART serial ports, which can support the UART serial port devices on the market.

Precautions:

1. Check the serial port voltage matches or not. Cannot directly connect to RS232, RS485 serial devices.
2. TX, RX Please confirm the connection is correct or not.

No.	Definition	Attributes	Description
1	5V	Power	5V output
2	TX	Output	TX
3	RX	Input	RX
4	GND	Ground	Ground

1. UART0 Adjustable by hardware RS232

2. UART1 Adjustable by hardware RS485

13. DEBUG interface

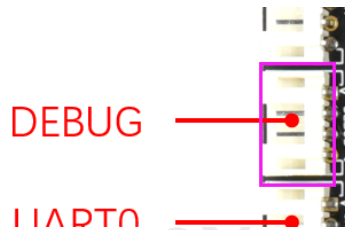

NO.	Definition	Attributes	Description
1	3V3	Power	3.3VOutput
2	TX	Output	TX
3	RX	Input	RX
4	GND	Ground	Ground

14. 4PIN RJ45 (Ethernet port)



NO.	Definition	Attributes	Description
1	TXP	Output	Output +
2	TXN	Output	Output -
3	RXP	Input	Input +
4	RXN	Input	Input -

15. TP Interface



NO.	Definition	Attributes	Description
1	3V3	power supply	3.3V output
2	SCL	Input/out	I2C clock
3	SDA	Input/out	I2C data
4	INT	Input/out	Interrupt
5	RST	Input/out	Reset
6	GND	Grounded	Grounded

16. 16pin HDMI OUT Interface

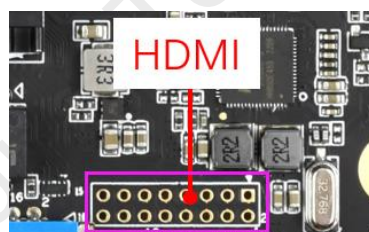

NO.	Definition	Attributes	Description
1	H2+	Output	TMDS Data2+
2	H2-	Output	TMDS Data2-
3	H1+	Output	TMDS Data1+
4	H1-	Output	TMDS Data1-
5	H0+	Output	TMDS Data0+
6	H0-	Output	TMDS Data0-
7	HC+	Output	TMDS Clock+
8	HC-	Output	TMDS Clock-
9	CEC	Output	CEC
10	SCL	Output	SCL
11	SDA	Output	SDA
12	HPD	Input	HDMI OUT hot plug detection signal
13	GND	Grounded	Grounded

14	GND	Grounded	Grounded
15	5V	5V positive	Output
16	GND	Grounded	Grounded
1	H2+	Output	TMDS Data2+
2	H2-	Output	TMDS Data2-
3	H1+	Output	TMDS Data1+
4	H1-	Output	TMDS Data1-
5	H0+	Output	TMDS Data0+
6	H0-	Output	TMDS Data0-
7	HC+	Output	TMDS Clock+
8	HC-	Output	TMDS Clock-
9	CEC	Output	CEC
10	SCL	Output	SCL
11	SDA	Output	SDA
12	HPD	Input	HDMI OUT hot plug detection signal

17. KEY Interface (extension) and Definition

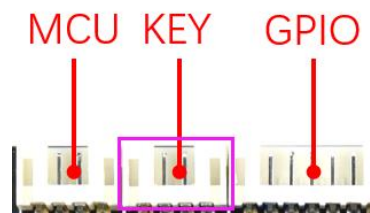

No.	Definition	Attributes	Description
1	PWRON	Power switch	External button, control power on and power off
2	RESET	Reset signal	Reset signal interface, Reserve
3	Recovery	ADC	ADC Reserve
4	GND	GND	GND

18. MCU Interface and Definition

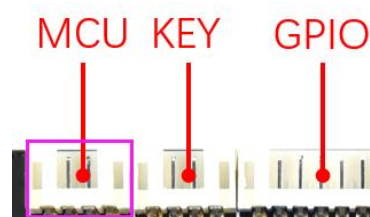

No.	Definition	Attributes	Description
1	3V3	POWER	3.3V Output
2	TX	Output	TX
3	RX	Input	RX
4	GND	GND	GND

19. Other Interfaces

Storage interface	SD card	Data storage, up to 32G
	USB	HOST interface, support data storage, data import, USB mouse keyboard, camera, touch screen, etc.
Ethernet interface	RJ45 interface	Support 100M wired network
HDMI interface	Standard interface	Support HDMI output, maximum support 4K
4G	PCI-E standard interface	Support various
SIM card interface	Standard interface	Support various standards (depending on 4G module)

Chapter III Communication Methods

I . Wi-Fi Update Program

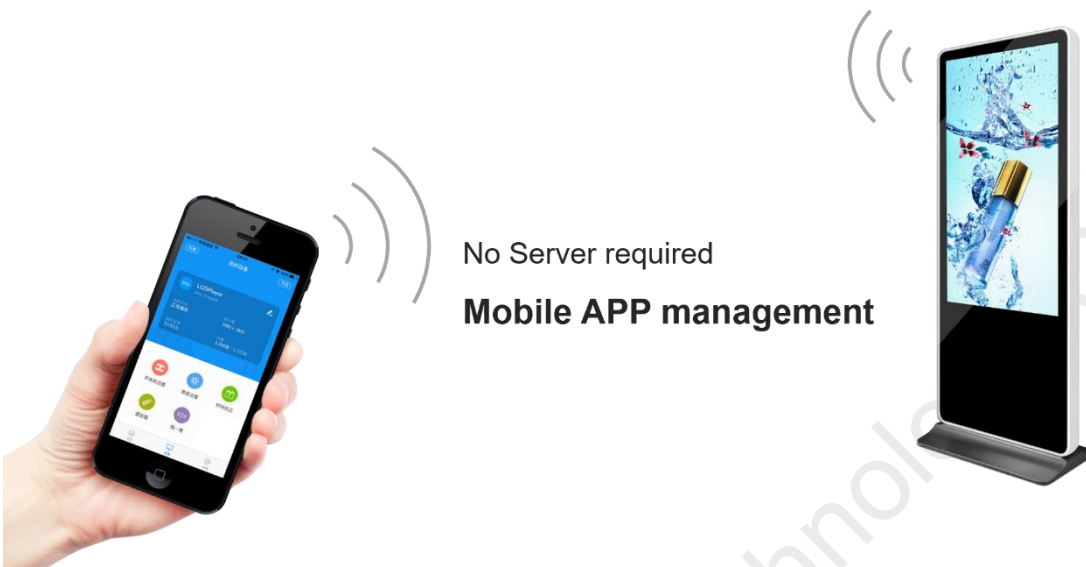

II. U-disk update program

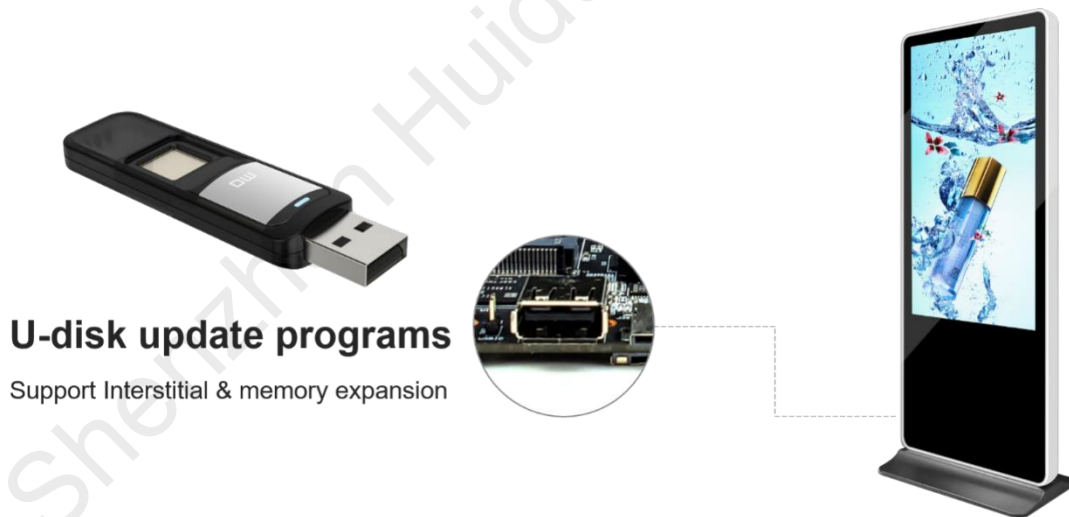

III. TF Card Update Program



TF card update programs

Support Interstitial & memory expansion



IV. Ethernet cable to Update

LAN or Internet

Network cable connection

LAN & Internet integrated management



V. Internet Update

Internet remote management

Anytime & anywhere operation available

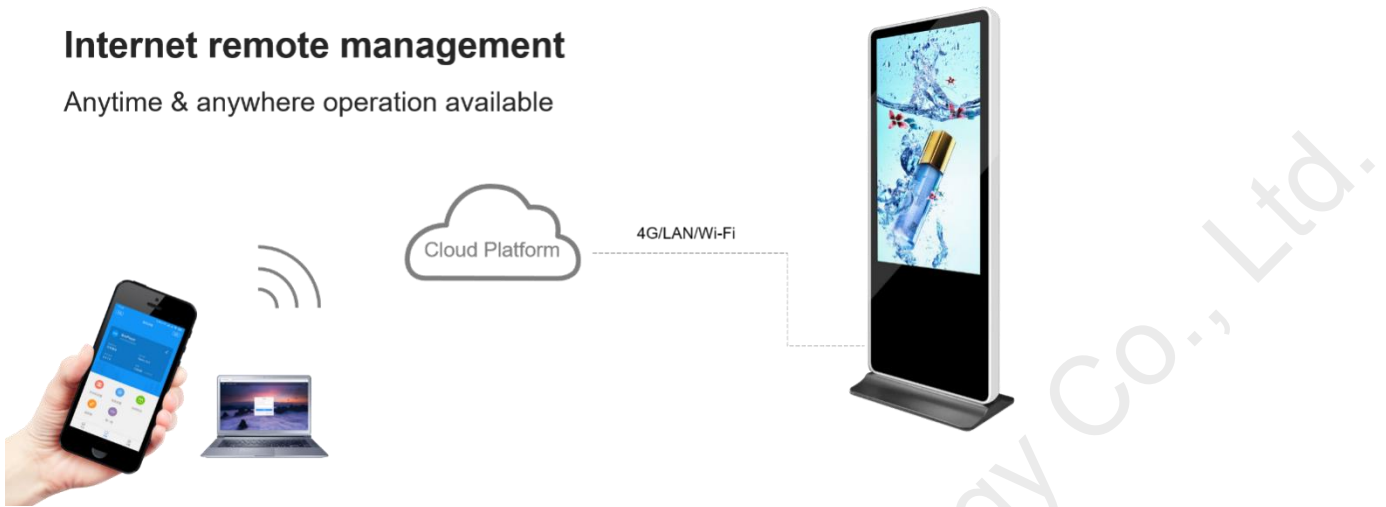

Chapter IV Appendix: Product Appearance

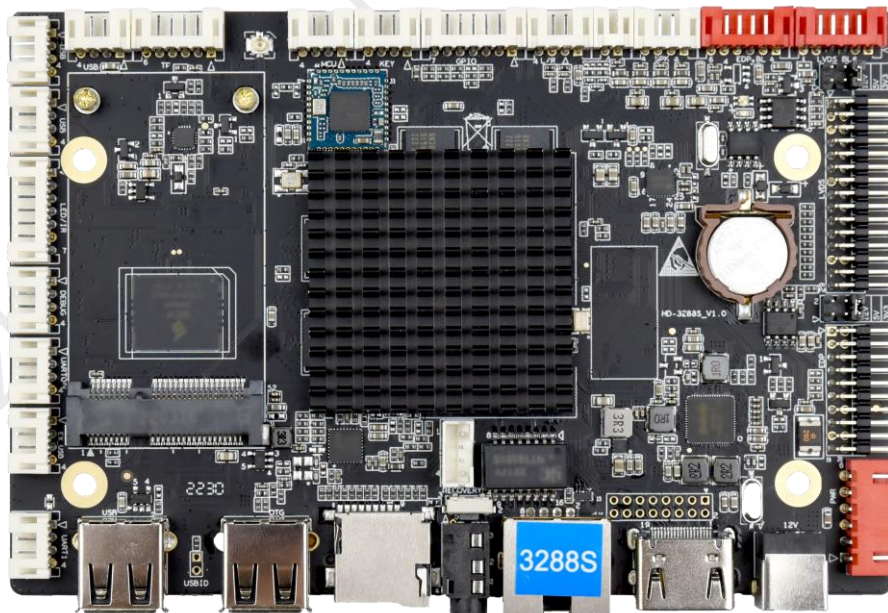

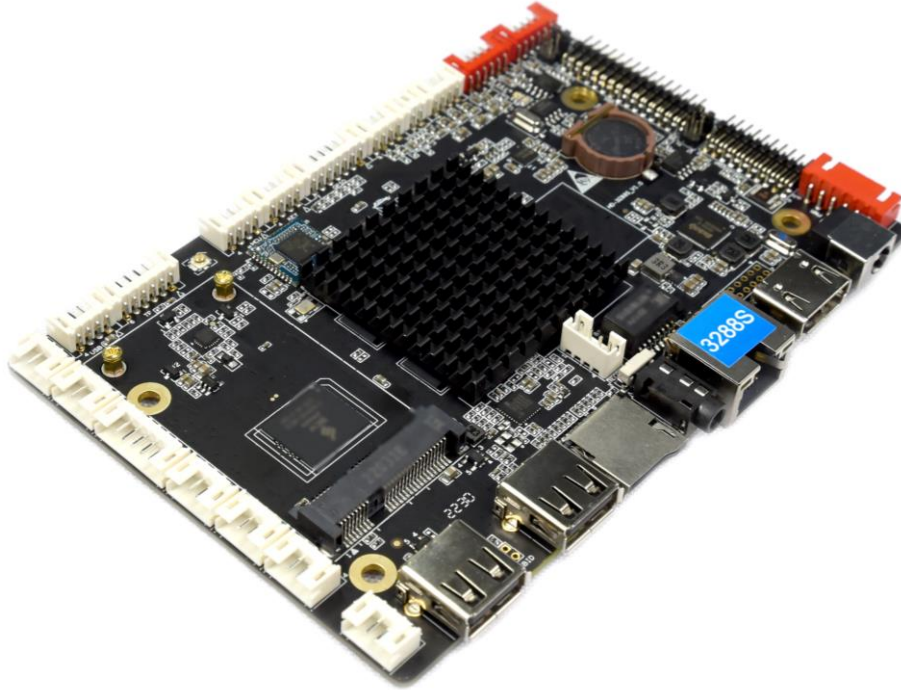

Note:

1. The 4G module is an optional accessory that is installed on the PCIE port. If the picture is different from the actual product, it is not a fake or inferior product. If you have any questions, please contact us for confirmation.
2. The model label is attached to the sales product. The product picture in the specification is different from the actual product. It is not a fake or inferior product. If you have any questions, please contact us for confirmation.
- 3. Do not operate with power on, Do not hot swap.**